

# Assembly and Installation Instructions

### Appendix 1: How to make a Current-Choke Balun using a Toroid Form:

A current-choke style balun may be used to prevent the antenna's feedline from interacting with the antenna and radial system. Best SWR performance was obtained with a choke similar to the one shown here installed at the antenna base.

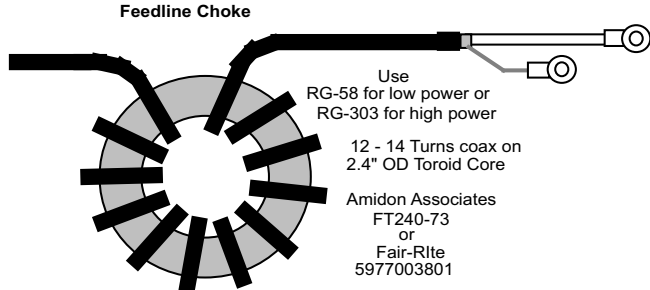

### MA8040V Specifications:

Frequency Coverage:	3.5-4.0 MHz, 7.0-7.3 MHz
Impedance:	50-Ohms
SWR:	1.1:1 typical at resonance
Bandwidth (2:1 SWR)	100 kHz on 80/75 meters, 300 kHz on 40 meters
Height:	23-27 feet (adjustable for 3.5 – 4.0 MHz coverage)
Weight:	9.0 LB (4.1 kg.)
Typical Gain:	0 dBi @ 3.5 MHz, 2 dBi @ 7 MHz
Ground Radials:	Eight recommended (4 x 65', 4 x 35')

### Limited Warranty:

Cushcraft Corporation, 48 Perimeter Road, Manchester, New Hampshire 03103, warrants to the original consumer purchaser for one year from date of purchase that each Cushcraft antenna is free of defects in material or workmanship. If, in the judgment of Cushcraft, any such antenna is defective, then Cushcraft Corporation will, at its option, repair or replace the antennas at its expense within thirty days of the date the antenna is returned (at purchaser's expense) to Cushcraft or one of its authorized representatives. This warranty is in lieu of all other expressed warranties, and implied warranty is limited in duration to one year. Cushcraft Corporation shall not be liable for any incidental or consequential damages which may result from a defect. Some states do not allow limitations on how long an implied warranty lasts or exclusions or limitations of incidental or consequential damages, so the above limitation may not apply to you. This warranty gives you specific legal rights and you may also have other rights which vary from state to state. This warranty does not extend to any products which have been subject to misuse, neglect, accident, or improper installation. Any repairs or alterations outside of the Cushcraft factory will nullify this warranty.

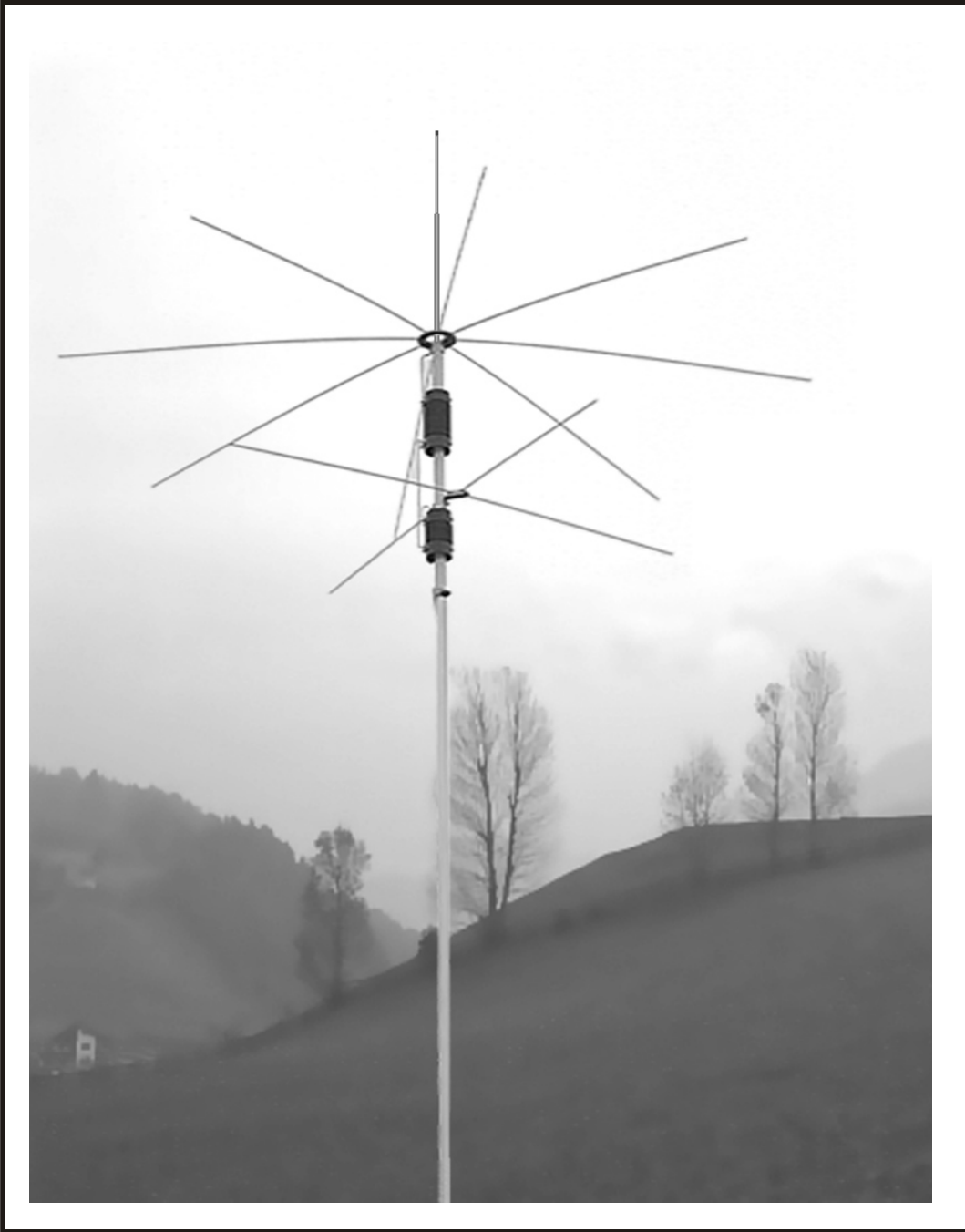

## Cushcraft MA8040V Dual-Band Vertical Antenna 80 – 40 Meter Vertical Monopole Antenna



48 Perimeter Road  
Manchester, NH 03103  
603-627-7877  
FAX 603-627-1764



**MA8040V General Description:** The MA8040V is a self-supporting monopole-style vertical for 80 and 40 meters. Parallel L/C resonators provide automatic bandswitching with full-band coverage from 7.0 – 7.3 MHz and adjustable tuning to any 100-kHz segment between 3.5 – 4.0 MHz. Heavy-duty loading coils and resilient stainless capacitive hats deliver high efficiency while handling up to 1500-Watts PEP. Designed especially for DX operation, the radiation pattern provides a low launch angle to favor distant contacts and a deep overhead null to cancel unwanted local QRM. The MA8040V weighs only 9 pounds for safe handling and ease of installation.

**Parts List:** Before assembling, read manual thoroughly and check contents against the parts list below:

X	Quan.	Part #	Description
[ ]	18	010009	5/8" x 8-32 screw
[ ]	1	010040	1-1/4" x 8-32 screw
[ ]	3	010123	1-1/2" x 8-32 screw
[ ]	2	010231	1-3/4" x 8-32 screw
[ ]	4	010120	2" x 8-32 screw
[ ]	1	014764	2-1/4" x 8-32 screw (Philips Head)
[ ]	45	010011	Hex nut, 8-32
[ ]	27	011941	Split lock washer, #8
[ ]	4	360941	Flat aluminum spacer washer, #10
[ ]	2	320056	Aluminum spacer, 1/4" x 5/16" OD
[ ]	10	100449	Star-locking solder lug
[ ]	2	194173	Small 90-degree aluminum bracket
[ ]	4	105630	1/2" x 1/4" OD loading coil standoff spacer.
[ ]	12	056249	Vinyl radial-rod cap
[ ]	1	055105	1/4" ID black vinyl tip cap
[ ]	4	030412	Large worm clamp
[ ]	3	030407	Small worm clamp
[ ]	1	MA8040VJ1	Formed jumper wire
[ ]	1	902428	Braid strap
[ ]	1	156336	1/2" ID tuning stub bushing
[ ]	1	MA8040VCA2	80-meter loading coil assembly
[ ]	1	MA8040VCA1	40-meter loading coil assembly
[ ]	4	226442	Stainless steel radial-rod stock, 0.1" X 25"
[ ]	8	226443	Stainless steel radial-rod stock, 0.1" X 31"
[ ]	3	194174	8-hole radial ring
[ ]	2	196242	Upper radial ring support bracket
[ ]	2	195393	Lower radial clip
[ ]	1	196230	Lower radial clip support bracket
[ ]	1	290326	Danger label
[ ]	1	296357	MA8040V Product Label
[ ]	1	096359	Radial wire kit (400' spool, #18 solid enamel)
[ ]	1	126228	Fiberglass resonator support, 1" OD x 29-1/2" tube
[ ]	1	126241	Fiberglass base insulator, 1.25" OD x 16" tube
[ ]	1	MA8040VBAT	Aluminum base radiator section-1, 1-3/8" OD x 36" tube
[ ]	1	MA8040VBB	Aluminum radiator splice section, 1-1/4" x 12" tube
[ ]	1	MA8040VBC	Aluminum radiator section-2, 1-3/8" x 72" tube
[ ]	1	MA8040VBD	Aluminum radiator section-3, 1-1/4" x 72" tube
[ ]	1	MA8040VBE	Aluminum radiator section-4, 1-1/8" x 72" tube
[ ]	1	MA8040VBAB	Aluminum base support section, 1-3/8" x 12" tube
[ ]	1	MA8040VBF	Aluminum resonator stub section-1, 1/2" OD x 23-7/8" tube
[ ]	1	MA8040VBG	Aluminum resonator stub section-2, 3/8" OD x 23-7/8" tube
[ ]	1	MA8040VBH	Aluminum resonator stub section-3, 1/4" OD x 23-7/8" aluminum rod

**Step-16: Tune-up and test**

Use a handheld SWR analyzer or transceiver with SWR meter to set up the MA8040V. If your radio has an auto tuner, turn it off while making adjustments. To lower the antenna for top-section adjustments without disrupting ground radials, loosen worm clamp and separate sections 1 and 2 (see **Figure-16** below).

[ ] **80 meters:** Adjust top section for minimum SWR at center of desired 100-kHz segment. Tuning may vary with different ground conditions and depending on proximity of other conductors. For best SWR at low end of band, clamp hat rods for maximum extension from the radial ring to increase hat diameter (refer back to **Step-10 Fig-10**). This setting lowers tuning range by 50 kHz. For best SWR performance at top of band or MARS coverage, set hat rods for minimum extension and remove one rod. Removing a rod increases range by 100- kHz). Use **Graph-1** below as a guideline for your initial resonator setting:

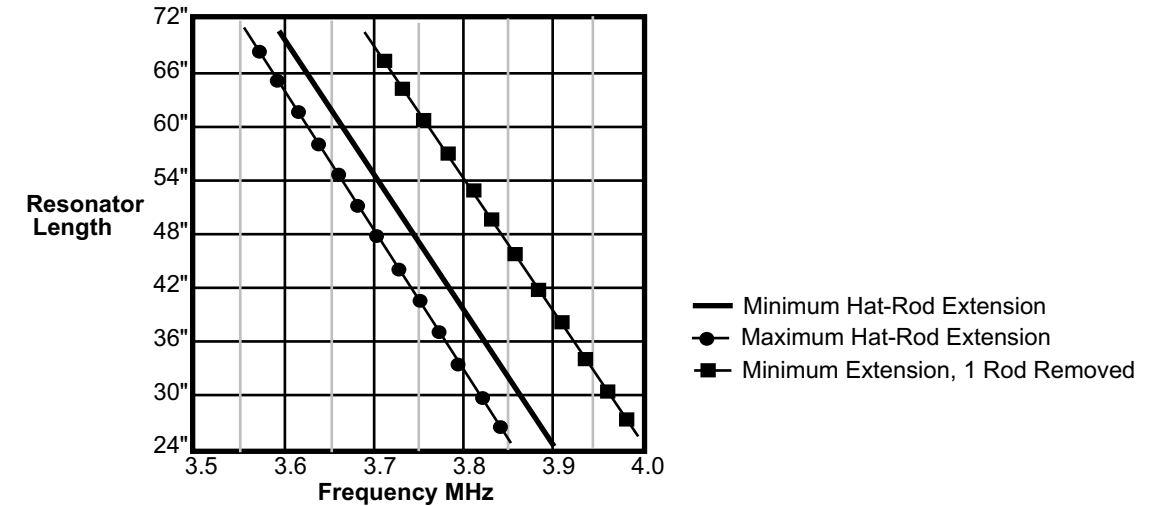

**Graph-1:** Suggested 80-meter Resonator Settings

[ ] **40 meters:** SWR should measure 2:1 or less across the entire 40-meter band with the 25" hat-rods provided. Tuning the 80-meter resonator will have little or no impact on 40-meter tuning.

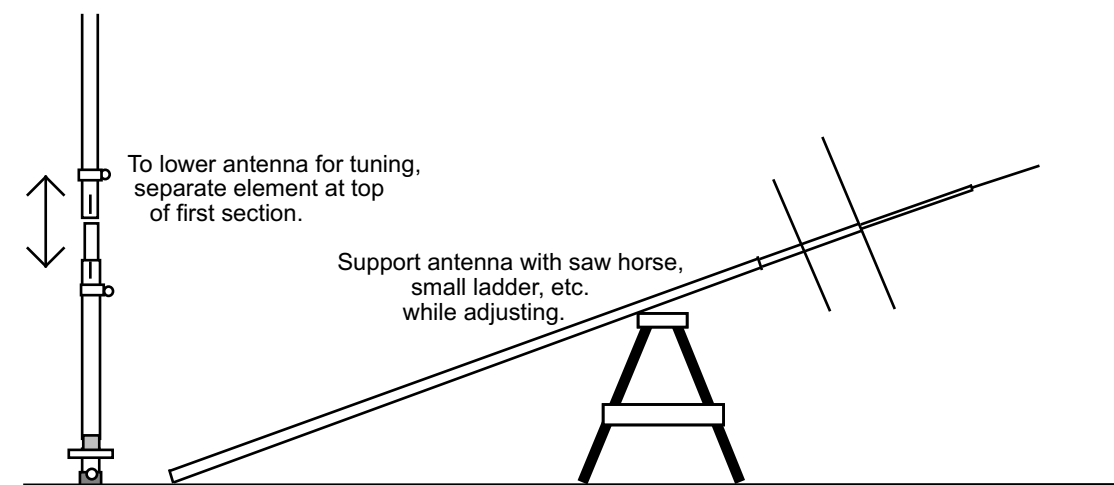

**Figure-16:** Handling antenna for tuning operation

Avoid tuning the MA8040V in wet weather—water droplets on coils and radiator surfaces will lower operating frequency artificially and result in mistuning.

### Step 14: Install Antenna on Base Section

1 030412 Large Worm clamp

- [ ] Slip a large worm clamp on top of base section, positioning below split in tube (see **Figure-14**).
- [ ] Carefully raise vertical radiator and insert splice tube into the base section.
- [ ] Slide worm clamp into position over split in tube and tighten in place.

#### Handling Precautions:

During installation, always use the buddy system to avoid injury and prevent antenna damage. Also, *never* attempt to raise an antenna near a power line or in high winds.

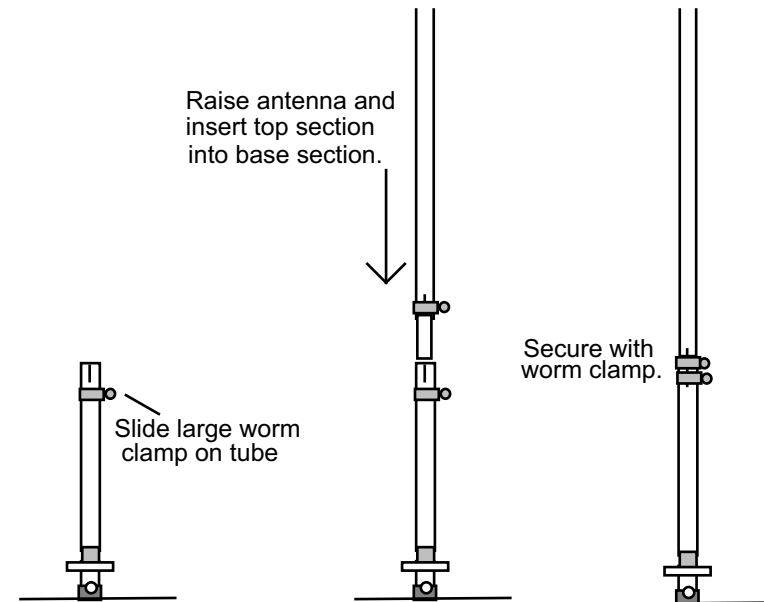
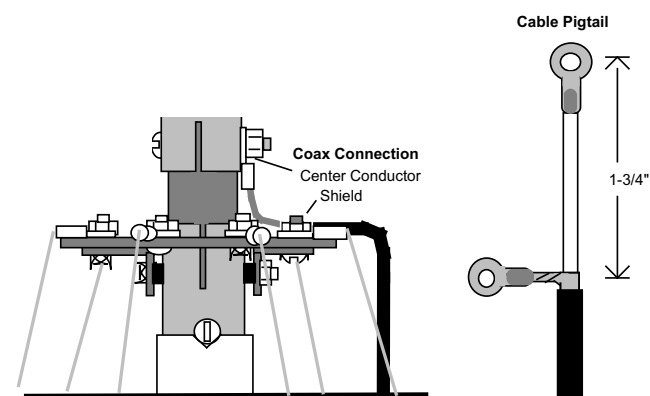

**Figure-14: Raising Antenna**

### Step-15: Connect feedline to antenna base.

2 100449 Solder lug

Prepare coax, as shown in **Figure-15**. Attach center conductor to main radiator and shield to ground radial ring using solder lugs. For best weather protection, flood braid with a weather-resistant liquid sealant such as Liquid Tape™. This will prevent water from entering the coax and wicking along the shield. Coil several turns of coax next to the antenna base or install a choke balun at the feed point (see **Appendix-1** for choke-balun fabrication instructions). Feedline leading to station may be buried between radials.



**Figure-15: Feedline Connection**

## Assembly Instructions- MA8040V

### Step 1: Using the following items, install aluminum tubes on base insulator.

1	MA8040VBAB	12" x 1-3/8" OD aluminum base section
1	MA8040VBAT	36" x 1-3/8" OD aluminum antenna section #1
1	126241	16" x 1-1/4" OD fiberglass base insulator
2	010231	1-3/4" x 8-32 screw
2	010011	#8 nut
2	011941	#8 lock washer

- [ ] Identify lower end of base insulator (two through-holes, 90-degrees offset).
- [ ] Install slotted end of 12" base tube on insulator and align screw holes.
- [ ] Insert 1-3/4" screw at **A**. Secure with lock washer and nut.
- [ ] Install 36" antenna section #1 over other end of insulator and align screw hole.
- [ ] Insert a 1-3/4" screw at **B**. Secure with a lock washer and nut.

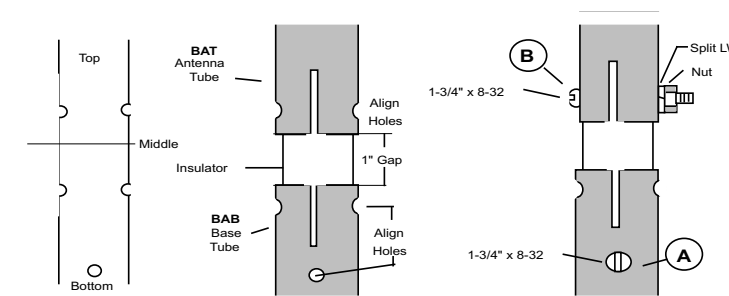
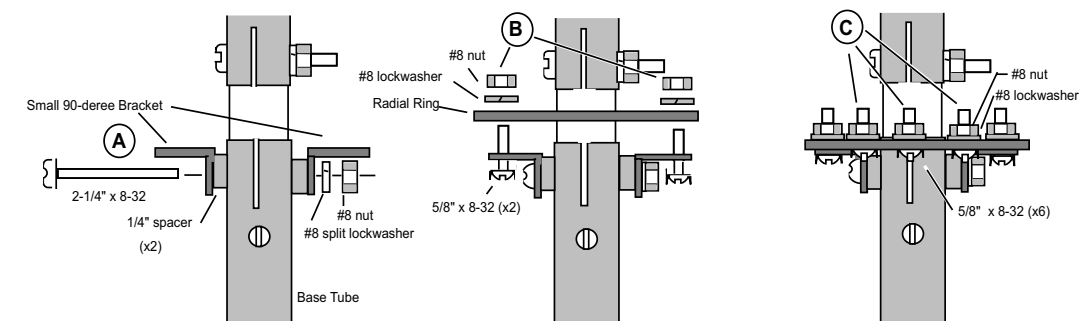

**Figure-1: Base Insulator Assembly**

### Step-2: Using the following items, assemble and install ground-radial attachment ring.

1	014764	2-1/4" x 8-32 SS screw
8	010009	5/8" x 8-32 SS screw
9	011941	#8 lock washer
9	010011	#8 nut
2	320056	1/4" spacer
1	194174	8-hole radial ring
2	194173	Small 90-degree aluminum bracket

- [ ] Find the 2-1/4" screw, two small 90° angle brackets, and two 1/4" spacers.
- [ ] Note that 90° angle brackets have *unequal sides*. Identify short side of each.
- [ ] Install bracket (short side) and a 1/4" spacer on the 2-1/4" screw.
- [ ] Insert screw through base tube as shown at **A**.
- [ ] Install other 1/4" spacer and bracket (short side) on protruding end of screw.
- [ ] Position brackets as shown and secure in place firmly using lock washer and nut.
- [ ] Insert 5/8" screws through angle brackets and place radial ring on top (**B**).
- [ ] Secure radial ring in place with lock washers and nuts (2 places)
- [ ] Install six 5/8" screws in open holes, secure with lock washers and nuts (**C**).

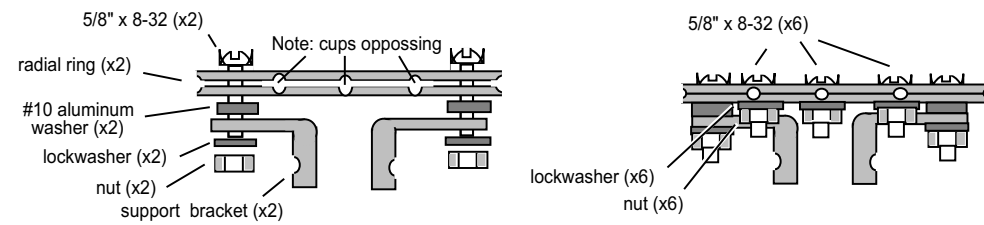

**Figure-2: Ground Radial Ring Assembly**

**Step-3: Using the following items, assemble upper (80-meter) capacitive-hat support ring:**

2	194174	8-hole radial ring
2	196242	Upper radial-ring support bracket
8	010009	5/8" x 8-32 screw
2	360941	#10 aluminum spacer washer
8	011941	#8 lock washer
8	010011	#8 nut

- [ ] Locate two radial rings and place together so cupped grooves oppose.
- [ ] Install two 5/8" screws from top side, as shown.
- [ ] From bottom side, install a #10 spacer washer and support bracket on each screw.
- [ ] Secure assembly using lock washers and nuts (finger-tighten only for now).
- [ ] Install six 5/8" screws in remaining holes, secure with lock washers and nuts.
- [ ] Set assembly aside for later installation.

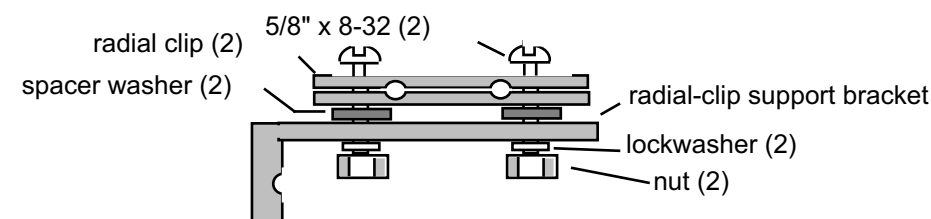

**Figure-3: Assembly Detail, Upper Hat**

**Step-4: Using the following items, assemble lower (40-meter) capacitive hat radial clip.**

2	195393	Lower 4-radial clip
1	196230	Lower radial clip support bracket
2	360941	#10 aluminum spacer washer
2	010009	5/8" x 8-32 screw
2	011941	#8 lock washer
2	010011	#8 nut

- [ ] Locate two radial clips and place together so cupped grooves oppose.
- [ ] Insert two 5/8" screws from top side, as shown.
- [ ] Install a spacer washer from bottom side on each screw.
- [ ] Insert both screws down through the radial-clip bracket, as shown.
- [ ] Secure bracket in place with lock washers and nuts (finger-tighten only).
- [ ] Set assembly aside for later installation.



**Figure-4: Lower Radial Clip Assembly**

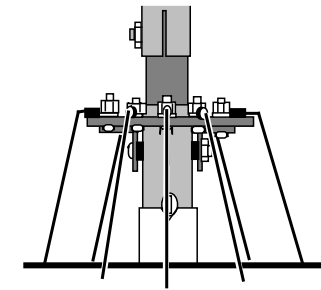

**Figure-12A: Connecting Radials to Base Radial Ring**

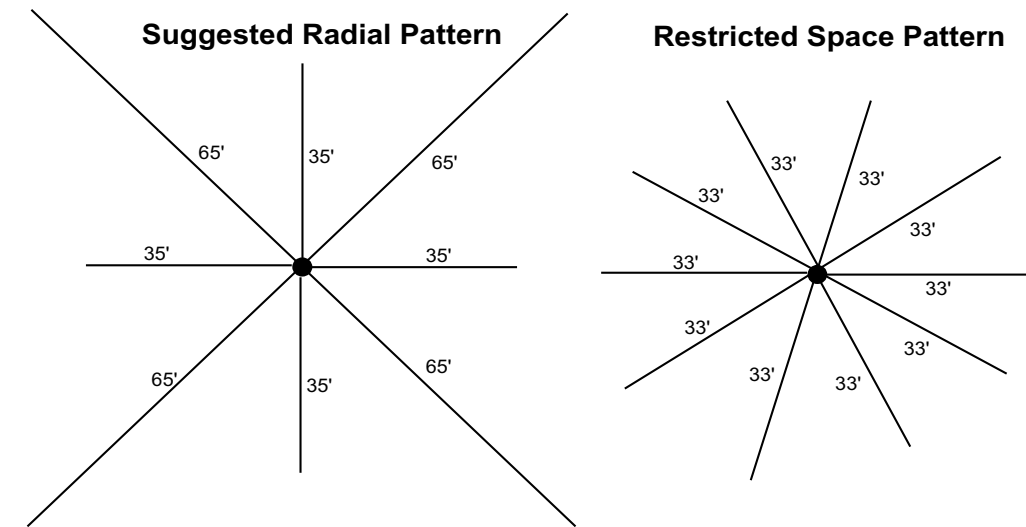

**Figure-12B: Recommended radial-wire layout**

**Important Note:** More than the prescribed number of radials may be installed on the MA8040V at your option in order to optimize radiation efficiency. However, note that as radials are added, SWR may eventually increase to an unacceptable level as driving resistance drops progressively further below 50 Ohms. Use the best compromise for your operating location.

**Step-13: Install Resonator on Vertical Radiator**

1	010123	1-1/2" x 8-32 screw
1	010011	#8 nut

- [ ] Slip the resonator tube inside the top of 1-1/8" radiator tube BE (**Figure-13**).
- [ ] Position the contact lugs over the tubing mounting holes, as shown.
- [ ] Using a 1-1/2" screw and 8-32 nut, secure resonator tube and coil wires in place. Tighten securely.

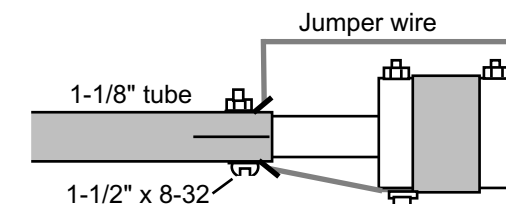

**Figure-13: Resonator Installation Detail**

bags of pre-mixed concrete are inexpensive and readily available at most major hardware outlets. Sink tube a *minimum of four feet* and plumb with a level to ensure a straight vertical mount. When installation is completed, use a hacksaw to remove damaged or un-needed exposed conduit. When sinking conduit in concrete, do not allow tube to fill within 10" of top. If tube fills above this level, the antenna's base assembly cannot drop inside.

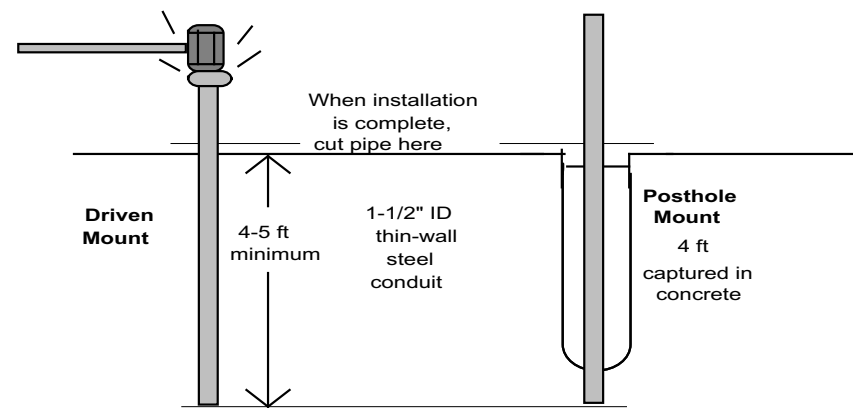

**Figure-11A:** Suggested base supports.

MA8040V base tube may be set into 1-1/2" thin-wall conduit or clamped to side of post (**Figure-10B**).

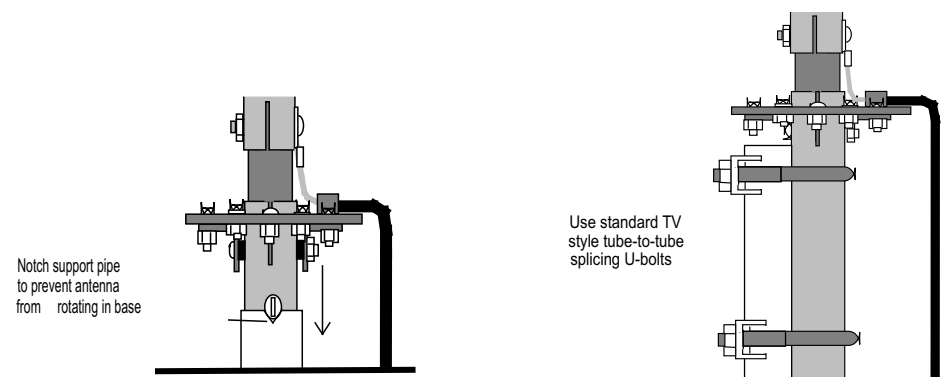

**Figure-11B:** Suggested mounting techniques

**Step-12: Install ground-radials**

- 1 096359 400' spool of #18 enameled radial wire
- 8 100449 Solder Lug

**Installation Tips:** When possible, bury wire 2-4 inches below surface. For lawns, split turf with edger, insert wire, then press turf back together. For rocky or wooded terrain, cover with topsoil, tamp down, and add ground-cover. Meander wire to skirt obstructions such as rocks and trees. If unable to extend '65 radials, we recommend cutting and installing twelve 33-foot radials as an alternative ground system.

- [ ] Install the antenna base assembly on its mount (see **Figure-12A**).
- [ ] Unroll, measure, and cut four 35-foot lengths of wire. Roll up and set aside.
- [ ] Unroll, measure, and cut four 65-foot lengths of wire. Roll up and set aside.
- [ ] At one end of each wire, remove enamel insulation and install a solder lug.
- [ ] Connect radials to base-section radial ring, alternating long and short lengths.
- [ ] Unroll and install each, creating the star pattern shown in **Figure-12B**.

**Step-5: Using the following items, install resonator loading coils.**

- 1 126228 24" Fiberglass resonator support tube
- 1 MA8040VCA2 80-meter loading coil
- 1 MA8040VCA1 40-meter loading coil
- 4 105630 Loading coil standoff spacer
- 4 010120 2" x 8-32 screw
- 8 010011 #8 nut

- [ ] On the insulator tube, identify the four coil-mount hole locations.
- [ ] Install a 2" screw in each coil-mount hole and secure with a nut.
- [ ] Install a spacer on each of the two 40-meter coil mounts at locations **A, B**.
- [ ] Find the 40-meter coil and identify the end with screw and longer lead.
- [ ] Orienting as shown at **E**, slide coil over tube and drop onto mounts. Secure with nuts.
- [ ] Find 80-meter loading coil and identify end with longer lead (**F**).
- [ ] Repeat the above procedure for the 80-meter coil at **C, D**.

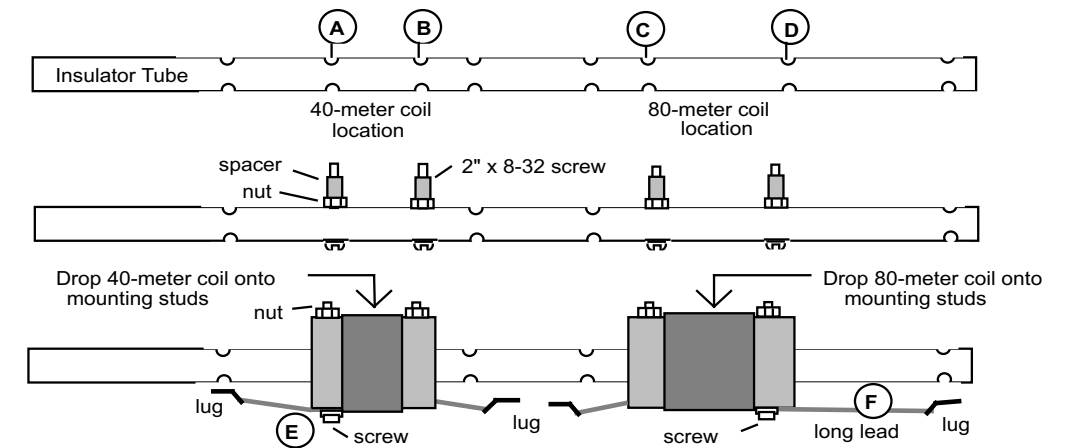
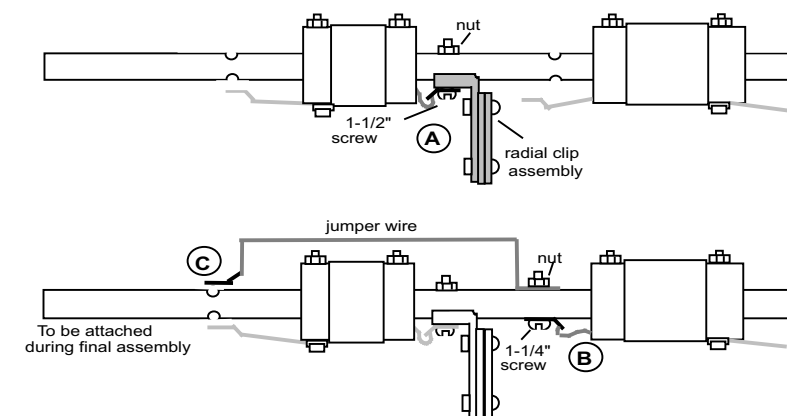

**Figure-5:** Loading Coil Mounting

**Step-6: Using the following parts, install lower radial clip and jumper wire.**

- 1 ----- Radial clip assembly (as completed in Step-4)
- 1 MA8040VJ1 80-meter resonator jumper wire
- 1 010040 1-1/4" x 8-32 screw
- 1 010123 1-1/2" x 8-32 screw
- 2 010011 #8 nut

- [ ] At **A**, use a 1-1/2" screw to install coil lug and 40-Meter radial-clip assembly, as shown.
- [ ] Secure in place with a nut.
- [ ] At **B**, install 1-1/4" screw through 80-Meter coil lead and insert through insulator tube.
- [ ] On opposite side, install one end of jumper wire and secure with nut.
- [ ] Position other end of jumper as shown at **C**. These leads will be attached to the antenna later on.

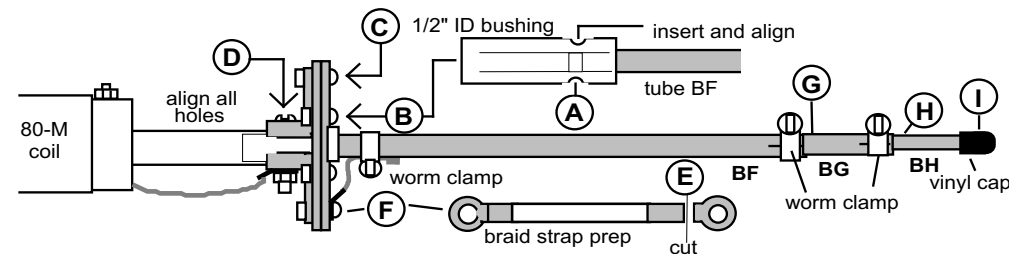

**Figure-6:** Loading Section Assembly

**Step-7: Using the following items, complete assembly of upper resonator.**

1	-----	80-meter radial ring assembly (as completed in Step-3)
1	MA8040VBF	1/2" OD x 24" resonator stub
1	MA8040VBG	3/8" OD x 24" resonator stub
1	MA8040VBH	1/4" OD x 24" resonator stub (solid rod)
1	055105	1/4" vinyl end cap
3	030407	Small worm clamp
1	010123	1-1/2" x 8-32 screw
1	902428	Braid strap
1	156336	1/2" ID 80-meter resonator-stub bushing

- [ ] Insert 1/2" tube (BF) into the 1/2" ID bushing and align screw holes (A).
- [ ] Install the bushing and tube inside fiberglass resonator tube. Align all screw holes (B).
- [ ] Slide 80-meter radial-ring assembly over outside of resonator tube, position with screw holes aligned (C).
- [ ] Install 1-1/2" screw at (D) and capture coil-lead lug at bottom. Secure with nut and tighten firmly.
- [ ] Find braid strap and nip eye off one end, as shown at (E).
- [ ] Using existing hardware on radial ring, attach braid strap at (F) and secure in place.
- [ ] Install small worm clamp on resonator tube and use to secure nipped end of braid.
- [ ] Install small worm clamp on end of 1/2" tube BF, insert 3/8" tube BG and secure (G).
- [ ] Install small worm clamp on end of 3/8" tube BG, insert 1/4" rod BH and secure (H).
- [ ] Slip 1/4" vinyl tip cap on end of 1/4" rod BH at (I). Resonator will be set to length later on.

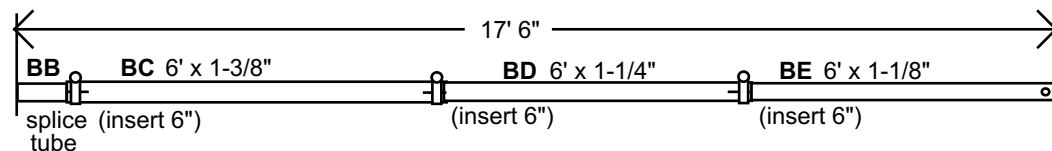

**Figure-7: Upper Resonator ( 80-meter) Assembly**

**Step-8: Using the following items, assemble antenna radiator.**

1	MA8040VBB	Aluminum splice tube, 12" x 1-1/4"
1	MA8040VBC	Aluminum radiator section-2, 72" x 1-3/8" OD
1	MA8040VBD	Aluminum radiator section-3, 72" x 1-1/4" OD
1	MA8040VBE	Aluminum radiator section-4, 72" x 1-1/8" OD
3	030412	Large Worm clamp

- [ ] Place a worm clamp on one end of tube BC (72" x 1-3/8").
- [ ] Find 12" x 1-1/4" splice tube BB. Measure off 6" and mark.
- [ ] Insert BB 6" inside BC, secure with worm clamp.
- [ ] Place a worm clamp at far end of tube BC.
- [ ] Find 72" x 1-1/4" tube BD and locate the un-slotted end. Measure off 6" and mark.
- [ ] Insert BD 6" inside BC and secure with clamp.
- [ ] Place a worm clamp on slotted end of BD.
- [ ] Find 72" x 1-1/8" tube BE and locate the un-slotted end. Measure off 6" and mark.
- [ ] Insert BE 6" into BD and secure with clamp.

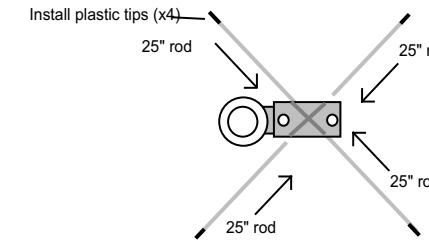

**Figure-8: Vertical Radiator Assembly**

**Step-9: Using the following items, install 40-meter capacitive-hat rods.**

1	-----	Pre-assembled resonator section (from Step-7)
4	226442	Radial rod stock, 0.1" x 25"
4	056249	Vinyl end caps

- [ ] Loosen the 40-meter radial-clip hardware.
- [ ] Install the four 25" rods, one in each clip opening. Tighten *securely* to capture all four rods.
- [ ] Install a plastic end cap on each protruding rod end (lubricate with soap, as needed, to install).

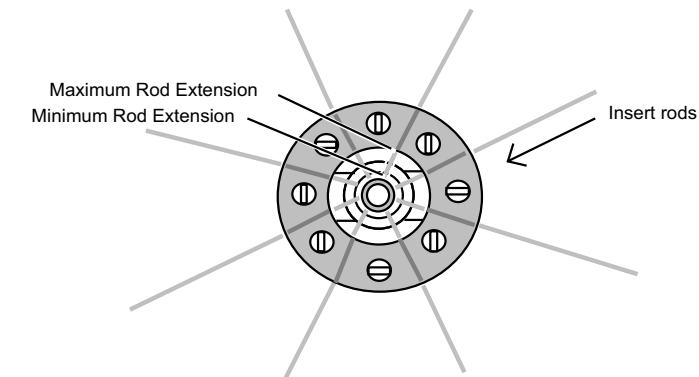

**Figure-9: Installing 40-meter Radial Rods**

**Step-10: Using the following items, install 80-meter rods on resonator assembly.**

8	226443	Radial-rod, 0.1" x 31"
8	056249	Vinyl end cap

- [ ] Install a vinyl end cap on one end of each rod (lubricate with soap, as needed, to install).
- [ ] Loosen radial-ring hardware and install rods, as shown in **Figure-10**.
- [ ] Use *maximum extension* for best low-end tuning, minimum for best high-end tuning. Tighten hardware.



**Figure-10: Inserting and adjusting radial rods**

**Step-11: Construct a base support.**

**Important Installation Site Safety Considerations:**

1. No part of the antenna should contact overhead tree branches or foliage.
2. Antenna must be well clear of all power wires if accidentally toppled in any direction.
3. RF-energized surfaces must be inaccessible to accidental contact by people or pets.
4. RF exposure of humans in nearby occupied areas should not exceed FCC guidelines.
5. Other feedlines, masts, towers, etc. must be sufficiently far away to avoid detuning.

The MA8040V requires a stable base support (owner supplied). Any suitable support may be used, but the antenna was especially designed to drop into 1-1/2" OD thin-wall steel galvanized conduit. This tubing may be either driven into the ground or set into a posthole and captured in concrete (**Figure-11A**). Conduit and